

PURCHASED ITEMS

KEY	DESCRIPTION	QTY.	U/M	INV. CODE	VENDOR NAME	PART/MODEL NUMBER	PART TYPE
1	1/4"-20 HEX NUT SS W/PLASTIC	4	EA	BI	MISC	250-20_HEXNUT	PART
2	1/4"-20 X 1 1/2" STUD BOLT	4	EA	BI	MISC	1_4-20_STUD	PART

DROP IN: 16 GA. STN/STL ALL WELDED CONSTRUCTION w/ INTEGRAL SINK. ALL HORIZONTAL AND VERTICAL CORNERS TO BE A 3/4" RADIUS. CREASE DRAIN BOARD (3/16")

NOTES: ALL STN/STL TO BE TYPE 300 SERIES.
ALL STN/STL TO BE POLISHED TO A NO. 3 FINISH.
ALL UNEXPOSED WELDS TO BE COVERED w/ ALUMINUM PAINT.
ALL METAL EDGES AND CORNERS TO BE FILED SMOOTH.

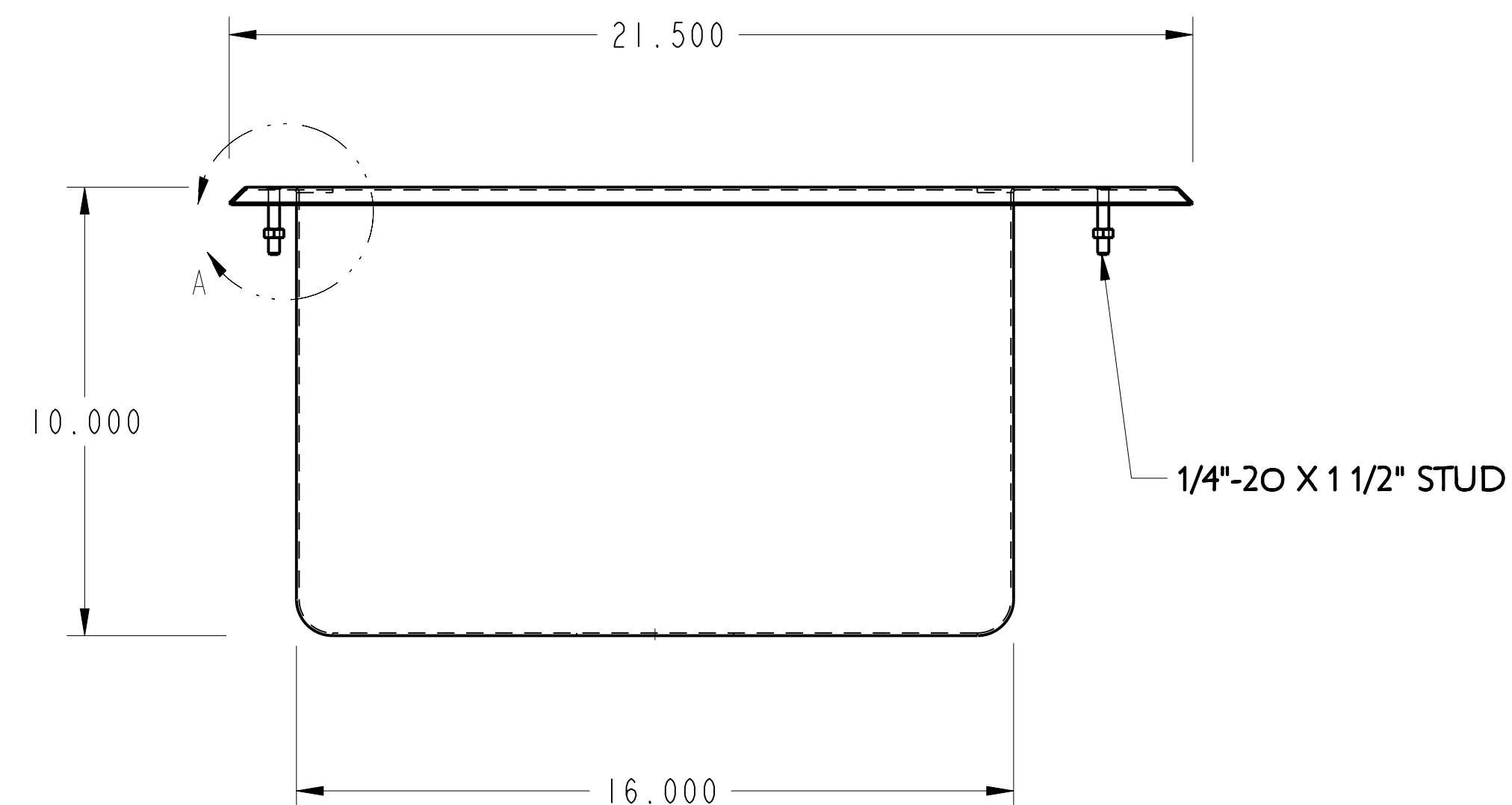
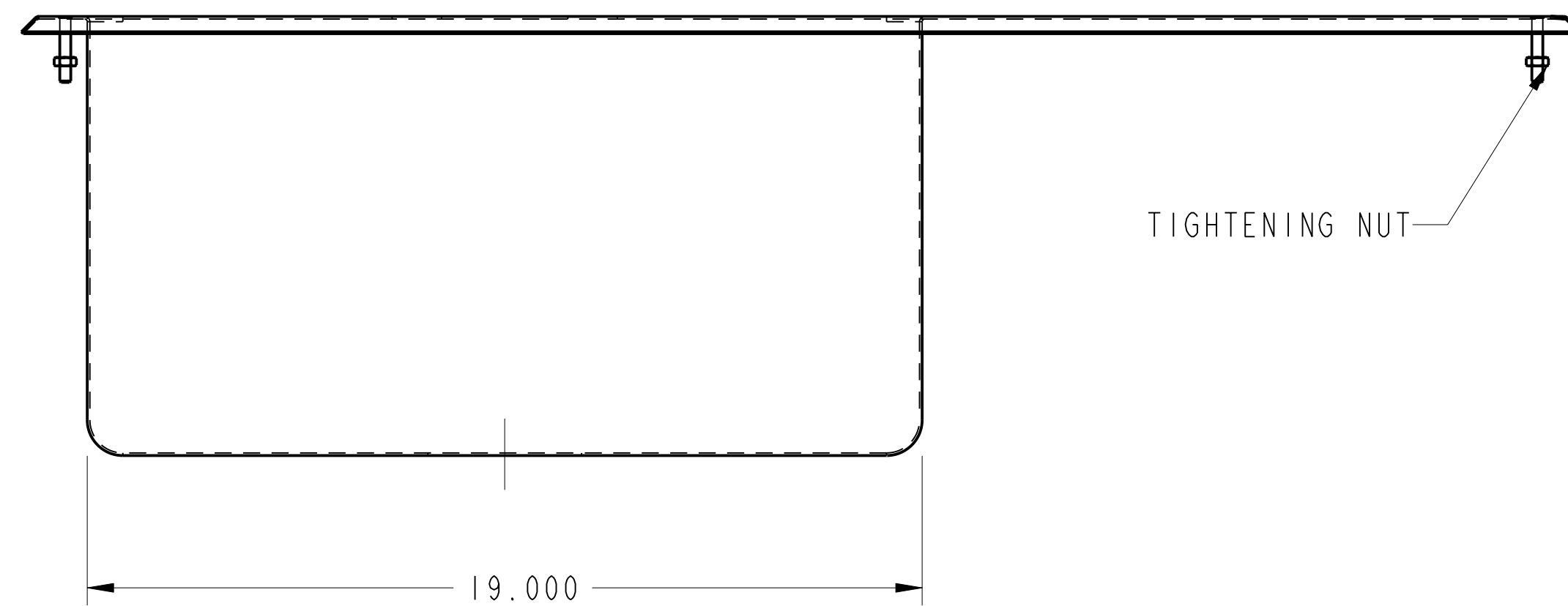
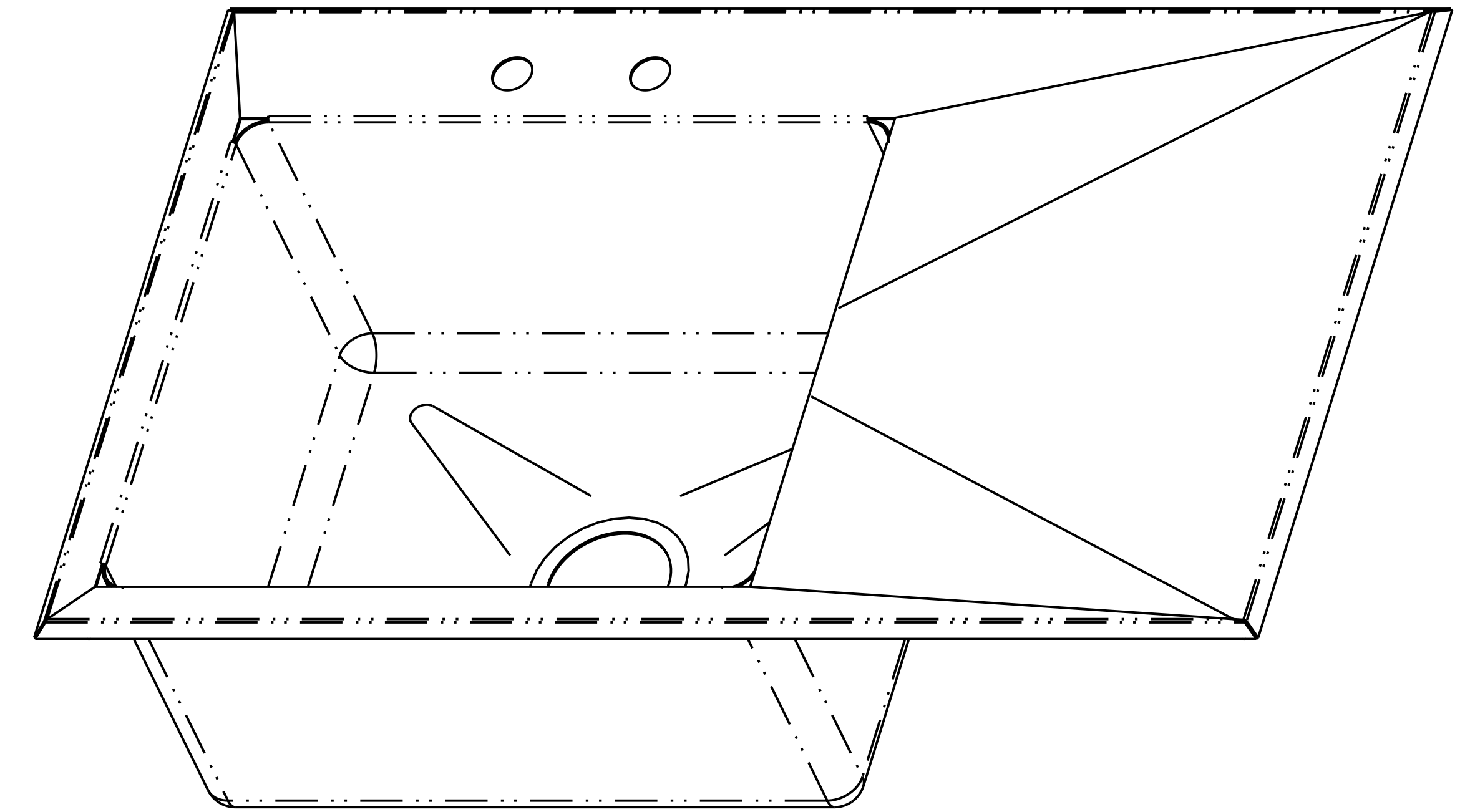
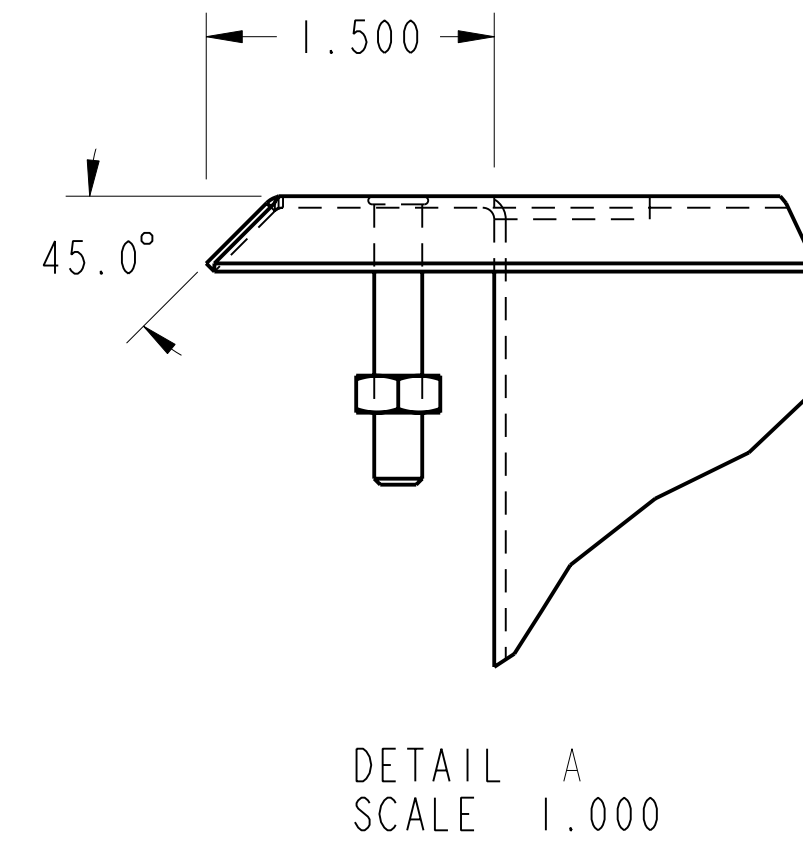
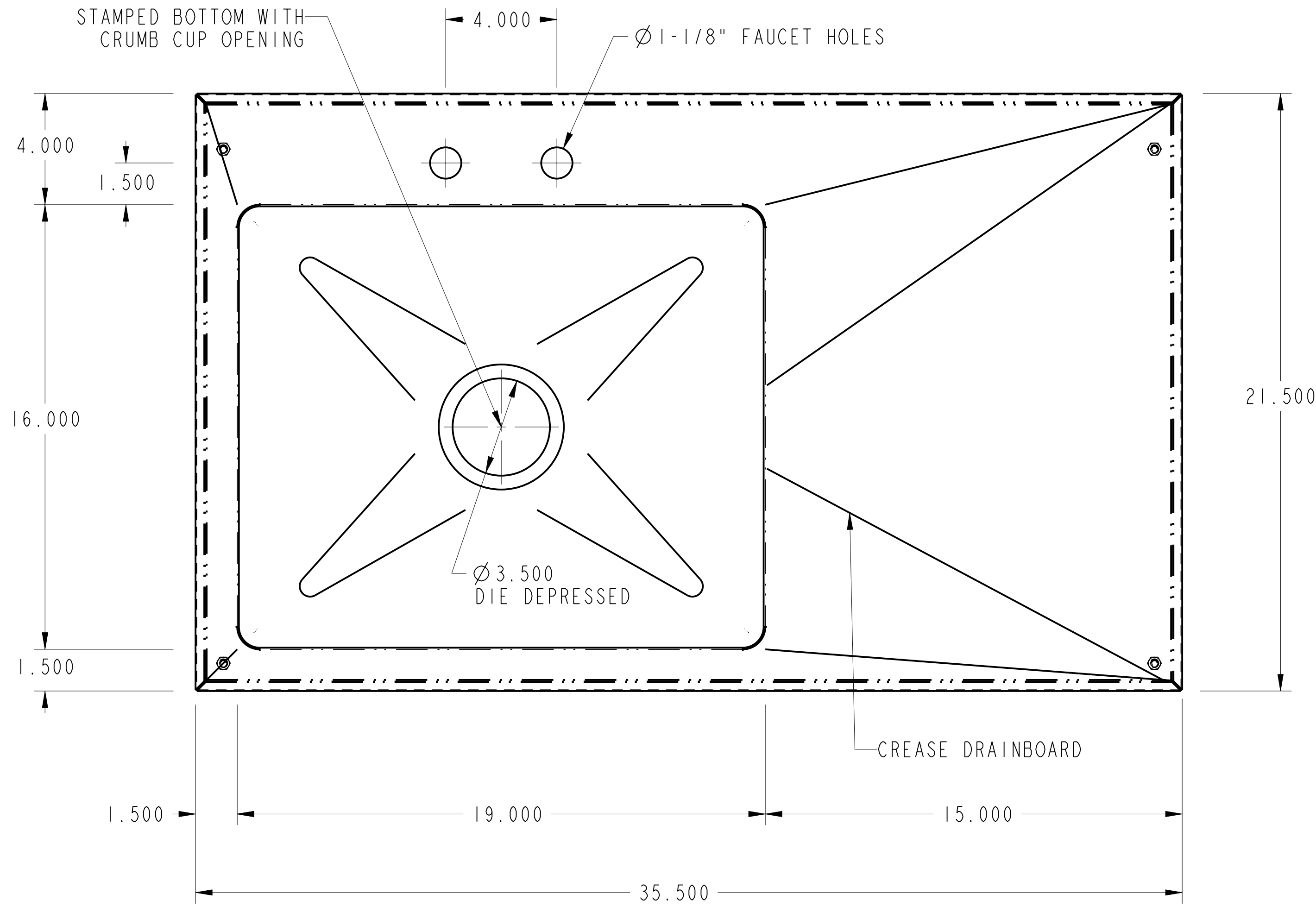

NO.	DATE	REVISIONS	BY
ASSEM		DWD-1-1916-10-15R	

