

S/S SUBWAY GRATE

The Subway grate is ideally suited for use in areas with heavy equipment, where strength is essential. Constructed of 1"x3/16" stainless steel bars spaced on 1" centers to stainless steel rods. This grate is highly recommended for maximum drainage.

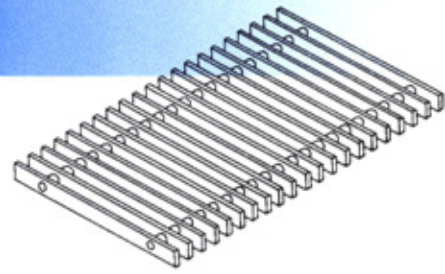

FRP NON-SLIP GRATE

The FRP (fiberglass reinforced plastic) grate is exceptionally strong yet lightweight. The "grit top" edge allows for firm footing, even when wet. The FRP grate is fire resistant and has a Class 1 flame spread rating of 25 or less. (ANSI No. 2.5, NFPA No. 2.55, UL No. 723 and UBC No. 42.1)

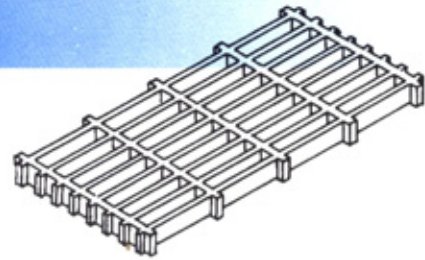

S/S LOUVERED GRATE

The Louvered grate offers cost effective, efficient draining for use in light duty areas where strength is not a primary concern. The louvered grate is constructed of 14 gauge, type 304, 18-8 stainless steel.

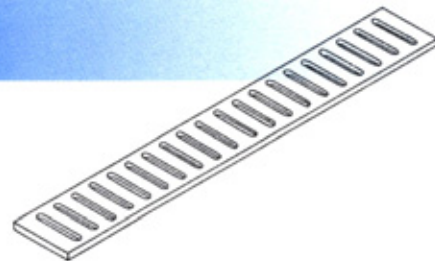

S/S STAMPED GRATE

The Stamped grate is designed for use in areas with heavy foot traffic, where appearance and safety are a concern. The 1/2" square holes, spaced 1" on center provide a smooth firm surface that will not "catch" on the wheels of small pushcarts and wheelchairs. The Stamped grate is constructed on 14 gauge, type 304, 18-8 polished stainless steel.

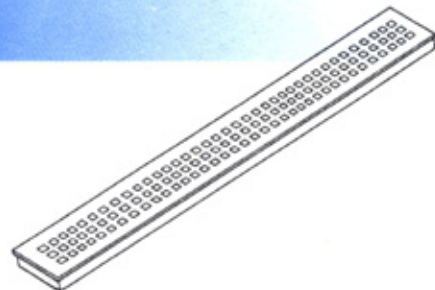

Floor Troughs & Floor Grates

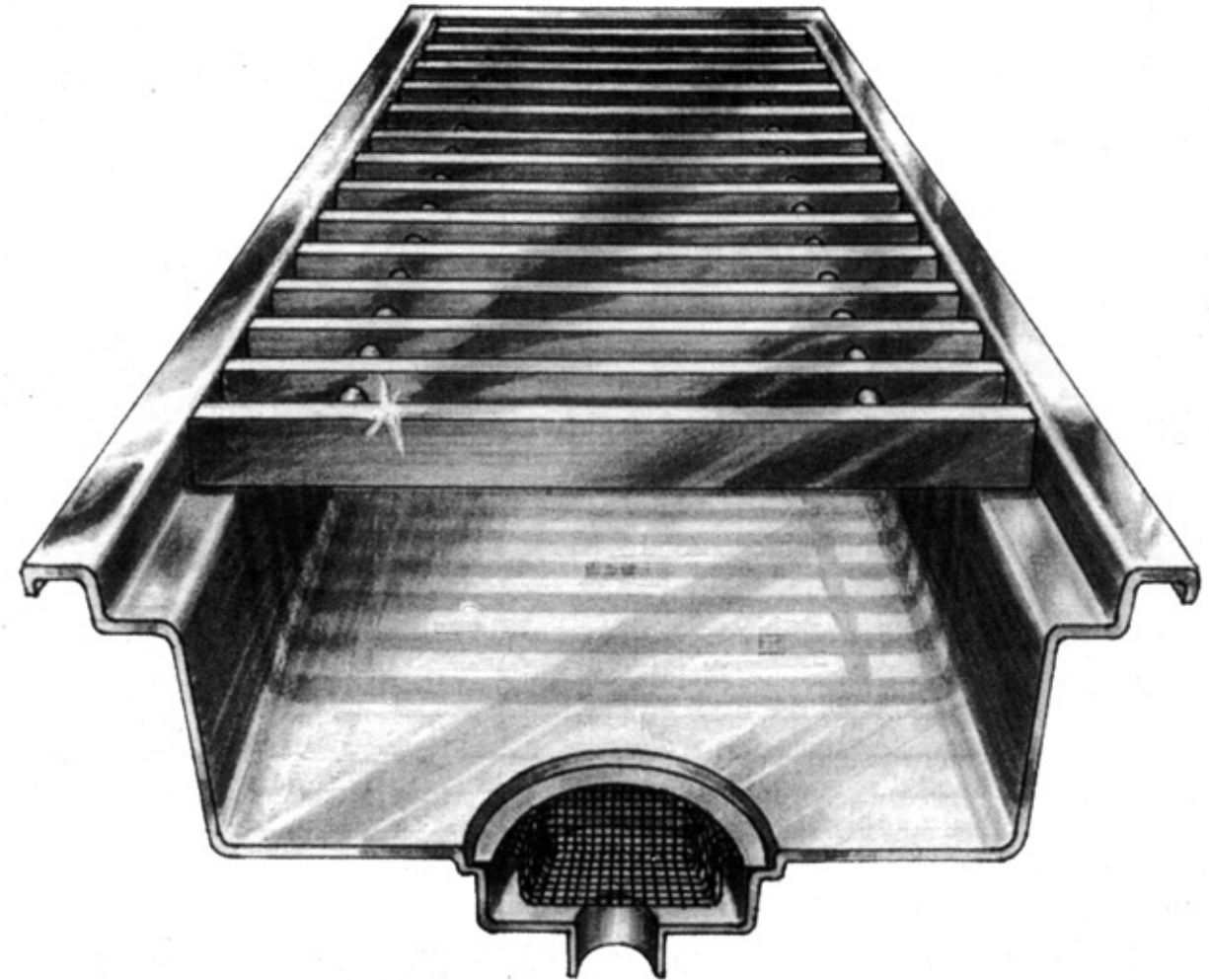

Installation Notes

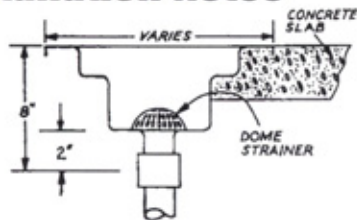

INSTALLATION AT TIME OF CONCRETE POUR

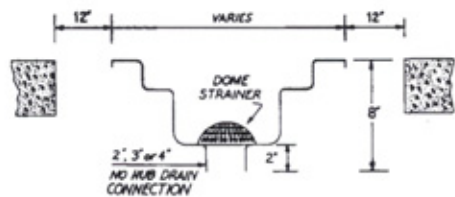

CONCRETE BLOCKOUT FOR FUTURE INSTALLATION

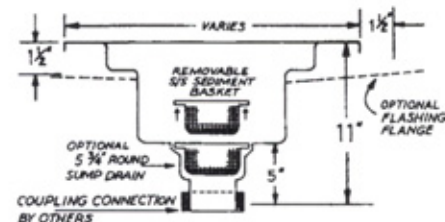

TROUGH INSTALLATION WITH OPTIONAL FLASHING FLANGE & SUMP DRAIN

Floor Troughs

The Professional's Choice

Engineered specifically for high demand commercial, industrial and institutional applications, Amtekco's floor troughs are the choice of professionals worldwide. Thirty years of experience in the design and fabrication of stainless steel products go into every trough we build.

Amtekco allows you to choose from a wide variety of trough sizes for different applications. We offer several grate configurations at standard prices.

See why Amtekco is the best choice!

Superior Construction

All troughs are constructed of 14 gauge, type 304, 18-8 stainless steel. Every seam is heli-arc welded and precision ground. Finally, all exposed surfaces are polished to provide easy maintenance. For added strength, each trough is laterally reinforced with 3/8 inch structural stainless steel rods.

Superior Design

Amtekco allows you to choose from a wide variety of trough configurations and offers 4 different styles of grates. Each trough is pitched to drain with dome strainers or optional sump drain and sediment basket.

Floor Trough / FT

- Standard lengths – 2' to 12'
- Standard widths – 12" to 18"
- Standard pitch – 1/4" to 1'
- Grates Available – S/S Subway*, S/S Louvered, FRP non-slip
- Options Available – Sump drain with removable sediment basket, Prison security grates, Flashing flange

Note: Dome strainer included with trough

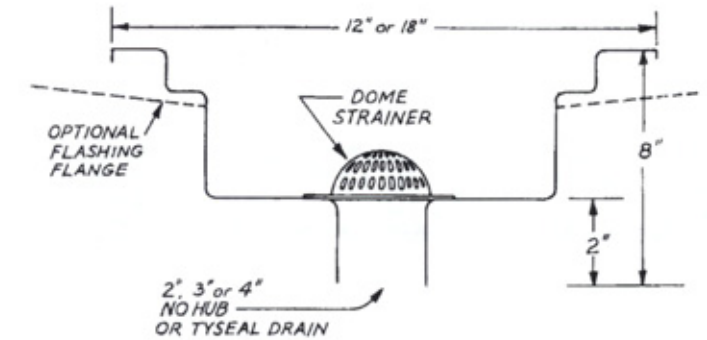
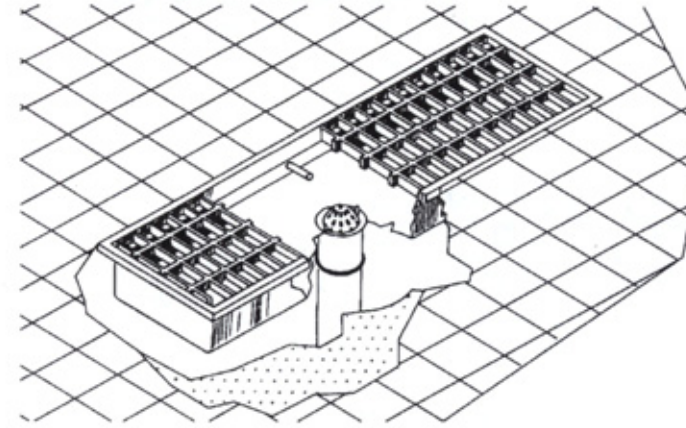

Kettle Trough / KT

- Standard lengths – 3' to 10'
- Standard widths – 24"
- Standard pitch – 1/4" to 1'
- Grates Available – S/S Subway*, FRP non-slip
- Options Available – Prison security grates, Flashing flange

Note: Sump drain assembly included with trough

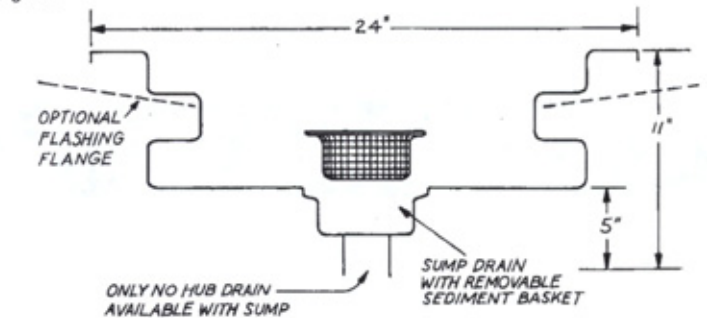
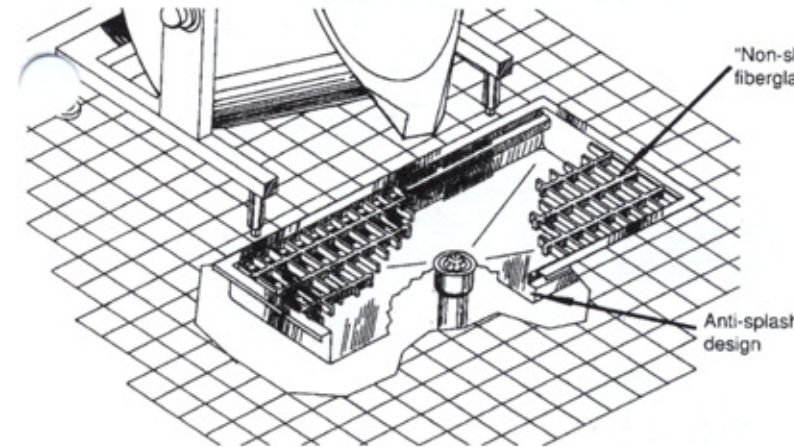

Threshold Door Trough / TD

- Standard lengths – 3' to 10'
- Standard widths – 6"
- Standard pitch – 1/4" to 1'
- Grates Available – S/S Stamped, FRP non-slip
- Drain Sizes Available – 2" only
- Options Available – Prison security grates, Flashing flange

Note: Dome strainer included with trough

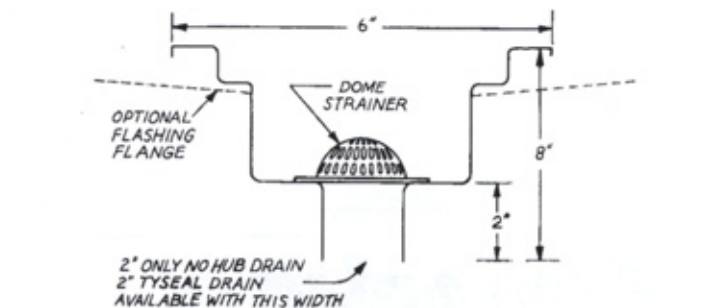
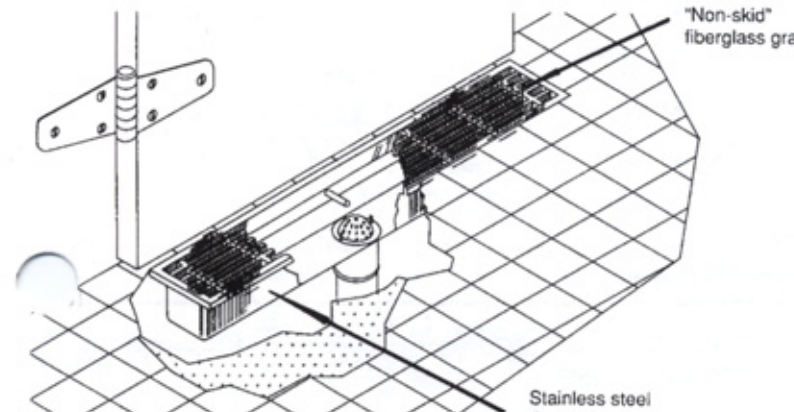

How to Specify

FT – 72 x 12 – w/subway grate

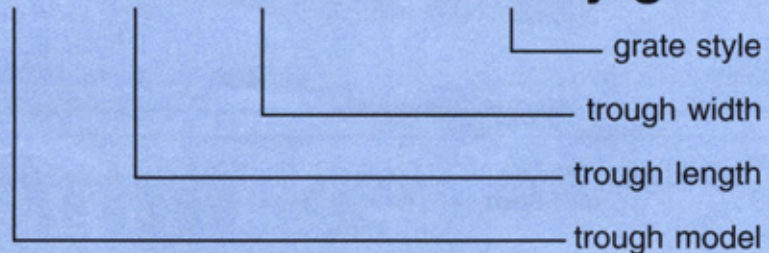

*Note: Floor S/S Subway grates are available to meet "New" A.D.A. requirements.

Stainless steel threshold trough for every need